

The MMB Networks BSB03PA1x family is the latest generation Zigbee and Thread capable module. Based on the EFR32 multi-protocol IC from Silicon Labs, the BSB03PA1x are drop-in Zigbee 3.0 solutions. Preloaded with MMB Networks' RapidHA Home Automation application, it offers hardware vendors an easy way to integrate a fully-implemented, automated Zigbee Home Automation platform into their existing devices.

MMB Networks offers a variety of hardware and software development tools to facilitate integration. For more information, please visit

<http://www.mmbnetworks.com>

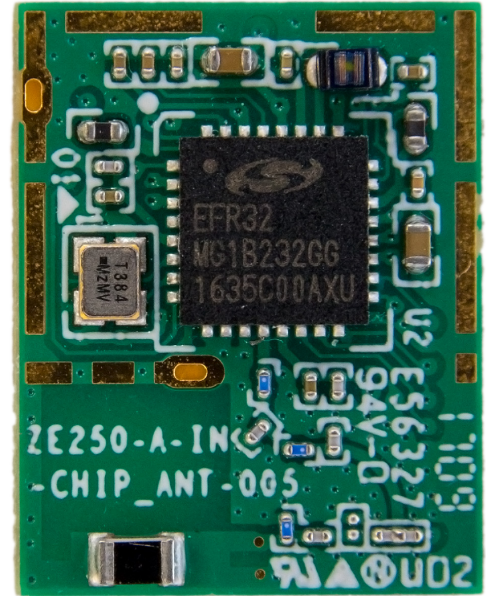

Features

- Pre-loaded with RapidConnect firmware
- Built on Silicon Labs EFR32 Wireless Gecko Family
- Certified application layer, onboard stack, antenna and regulatory approvals
- Up to 118 dB link budget
- SMD Chip Antenna or U.FL RF connector options
- 15.88mm x 12.6mm x 2.4mm module size
- +19.5, +16.5, and +7dBm transmit power options
- 15 GPIO (General Purpose Input/Output) connections

Benefits

- Ensures compatibility with latest Zigbee and Thread specifications
- Industry leading 802.15.4 MCU ensures best-in-class performance
- Provides rapid time-to-market and short implementation time
- Delivers unmatched range for difficult installations
- Allows for external antennas where required
- Tiny module size will fit in the most miniature applications
- Power and price optimized to meet end product transmit power requirements
- Flexibility to drive simple to complex devices

Contents

1 General Information	3
2 Memory	3
3 Module Pinout	3
3.1 Debug and Programming Interface.....	4
4 Electrical Specifications	4
4.1 Absolute Maximum Ratings.....	4
4.2 Recommended Operating Conditions.....	4
4.3 DC Electrical Characteristics	5
4.3.1 Typical Transmit Performance Curves (Supply Current vs. Tx Power Setting).....	5
5 RF Specifications	6
5.1 Receive Specifications.....	6
5.2 Transmit Specifications.....	6
5.2.1 Typical Transmit Performance Curves (Output Power vs. Tx Power Setting).....	7
6 Functional Specifications	7
6.1 Serial Ports	7
7 Mechanical Specifications	8
7.1 Module Physical Dimensions and Host PCB Antenna Keep-out.....	8
7.2 Recommended Land Pattern (Surface Mount)	9
7.3 RF Connector Dimensions.....	10
7.4 Label Drawings.....	10
8 Soldering Temperature Time Profile for reflow soldering (Lead-free solder)	11
9 Regulatory Approvals	11
9.1 Federal Communications Commission (FCC - US).....	11
9.2 Industry Canada (IC)	12
9.3 EU.....	13
9.4 RoHS Compliance	13
10 Revision History	13
11 Ordering Information	14

1 | General Information

Note that some of the specifications refer to either the “EFR32MG1” chip or the “Module”. Specifications cited as EFR32 are taken from the EFR32MG1 datasheet (this should also be noted where referred to). Module means measurements taken with our production module.

2 | Memory

RAM (kB)	On-Chip Flash (kB)
32	256

3 | Module Pinout

Module Pad	Function	EFR32 Pin Name (number)	Mini Simplicity Debug Interface	ADC Capable
1	2.4GHz antenna line out	2G4RF_IOP (12)		
2	Module Ground			
3	EFR32 GPIO, Port D #13	PD13 (14)		Yes
4	EFR32 GPIO, Port D #14	PD14 (15)		Yes
5	EFR32 GPIO, Port D #15	PD15 (16)		Yes
6	EFR32 GPIO, Port A #1	PA1 (18)	UART1_RX	Yes
7	EFR32 GPIO, Port A #0	PA0 (17)	UART1_TX	Yes
8	Digital I/O Power Supply	IOVDD (30)		
9	EFR32 GPIO, Port B #11	PB11 (19)		Yes
10	EFR32 GPIO, Port B #12	PB12 (20)	PTI_DATA	Yes
11	Module Ground			
12	Module Ground			
13	Module Ground			
14	EFR32 GPIO, Port B #13	PB13 (21)	PTI_FRAME	Yes
15	EFR32 GPIO, Port B #14	PB14 (23)		Yes
16	EFR32 GPIO, Port B #15	PB15 (24)		Yes
17	Module Ground		GND	
18	Module Main Power		VAEM	
19	Module Ground			
20	EFR32 GPIO, Port C #10	PC10 (31)		Yes
21	EFR32 GPIO, Port C #11	PC11 (32)		Yes
22	Module Ground			
23	Reset input, active low	RESETn (8)	RESET_N	
24	EFR32 GPIO, Port F #0	PF0 (1)	SW_CLK	Yes
25	EFR32 GPIO, Port F #1	PF1 (2)	SW_DIO	Yes
26	EFR32 GPIO, Port F #2	PF2 (3)	SW_O	Yes
27	Module Ground			
28	RFGND1			
29	RFGND2			

3.1 | Debug and Programming Interface

In order to access the EFR32 for programming and debug purposes, it is recommended that the designer incorporate Silicon Labs 10-pin Mini Simplicity connector.

The following table shows a pin mapping between Silicon Labs 10-pin Mini Simplicity connector and the module, and the graphic to the right displays the layout of the Mini Simplicity connector.

Silicon Labs Simplicity Studio Port Pin	Module Pad
1	8 (Digital I/O Power Supply)
2	17 (Module Ground)
3	23 (Reset input, active low)
4	6 (EFR32 GPIO, Port A #1)
5	7 (EFR32 GPIO, Port A #0)
6	26 (EFR32 GPIO, Port F #2)
7	25 (EFR32 GPIO, Port F #1)
8	24 (EFR32 GPIO, Port F #0)
9	14 (EFR32 GPIO, Port B #13)
10	10 (EFR32 GPIO, Port B #12)

VAEM	1	2	GND
RST	3	4	VCOM_RX
VCOM_TX	5	6	SWO
SWDIO	7	8	SWCLK
PTI_FRAME	9	10	PTI_DATA

4 | Electrical Specifications

4.1 | Absolute Maximum Ratings

Parameter	Minimum	Maximum	Units
Supply Voltage (VCC)	0	3.6	V
Voltage on any GPIO	-0.3	VCC + 0.3	V
Ambient Operating Temperature (standard version)	-40	85	°C
Storage Temperature	-50	150	°C

4.2 | Recommended Operating Conditions

Parameter	Minimum	Typical	Maximum	Units
Supply Voltage (VCC)	2.0	3.3	3.6	V
Temperature Range	-40		85	°C

4.3 | DC Electrical Characteristics

Parameter	Test Condition	Minimum	Typical	Maximum	Units
TX Current	At 25 °C, VCC = 3.3v, normal mode, 19.5 dBm		138	150	mA
	At 25 °C, VCC = 3.3v, normal mode, 16.5 dBm		99	110	mA
	At 25 °C, VCC = 3.3v, normal mode, 10.5 dBm		49	55	mA
	At 25 °C, VCC = 3.3v, normal mode, 7 dBm		36	40	mA
RX Current	At 25 °C, VCC = 3.3v, normal mode, 2.4 GHz, CPU asleep		10.6	12.5	mA
	At 25 °C, VCC = 3.3v, normal mode, 2.4 GHz, CPU running		13.7	14.5	mA
Deep Sleep Current	At 25 °C, VCC = 3.3v, shutdown mode. Full RAM retention and RTCC running from LFXO (EM2 mode)		2.3	4	μA

4.3.1 | Typical Transmit Performance Curve (Supply Current vs. Tx Power)

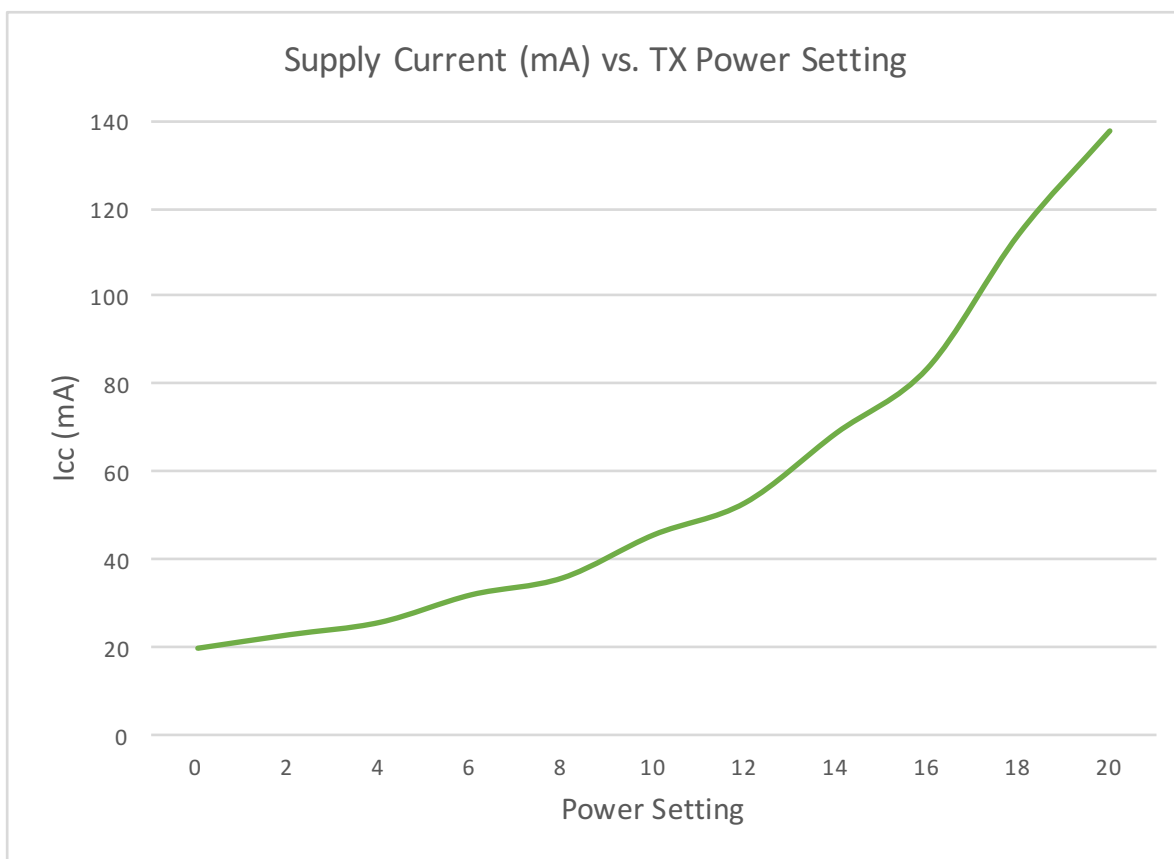

Note: The graph above is for the PA10 variant. For PA11 and PA12 modules, the maximum output power is limited by the chosen SKU (16.5dBm or 7dBm respectively)

5 | RF Specifications

5.1 | Receive Specifications

Note: The Typical number indicates one standard deviation above the mean, measured at room temperature (25°C). The Min and Max numbers were measured over process corners at room temperature.

Parameter	Test Condition	Min	Typical	Max	Units
Frequency range		2400		2483.5	MHz
Sensitivity ¹	1% PER, 20 byte packet defined by IEEE 802.15.4-2003		-98	-97	dBm

Note 1: Channel 14 and 25 have typical sensitivity of -96dBm and maximum of -95dBm.

5.2 | Transmit Specifications

Parameter	Test Condition	Min	Typical	Max	Units
Output Power at highest power setting, general limit ¹	BSB03PA10, FCC/IC region	18.1	19.1		dBm
	BSB03PA11, FCC/IC region	15.8	16.7		dBm
	BSB03PA11-CHP, CE region	9.4	10.4		dBm
	BSB03PA12 all regions	5.9	7.1		dBm
Channel 26 output power	BSB03PA10-RFC or BSB03PA11-RFC	7.3	8.2		dBm
	BSB03PA1X-CHP ²	5.3	6.2		dBm
Antenna Gain	Chip antenna (used on -CHP), P/N : ACA-2012-A1-CC-S		1.2		dBi
	External antenna (for use with -RFC), P/N 1: EDA-1713-2G4C1-A2 P/N 2: G-RA0K13200284-SZ478		4.5		dBi

Notes:

1. RF channel 26 operates at special reduced power levels.
2. 1X includes BSB03PA10, PA11, and PA12 variants

5.2.1 | Typical Transmit Performance Curves (Output Power vs. Tx Power Setting)

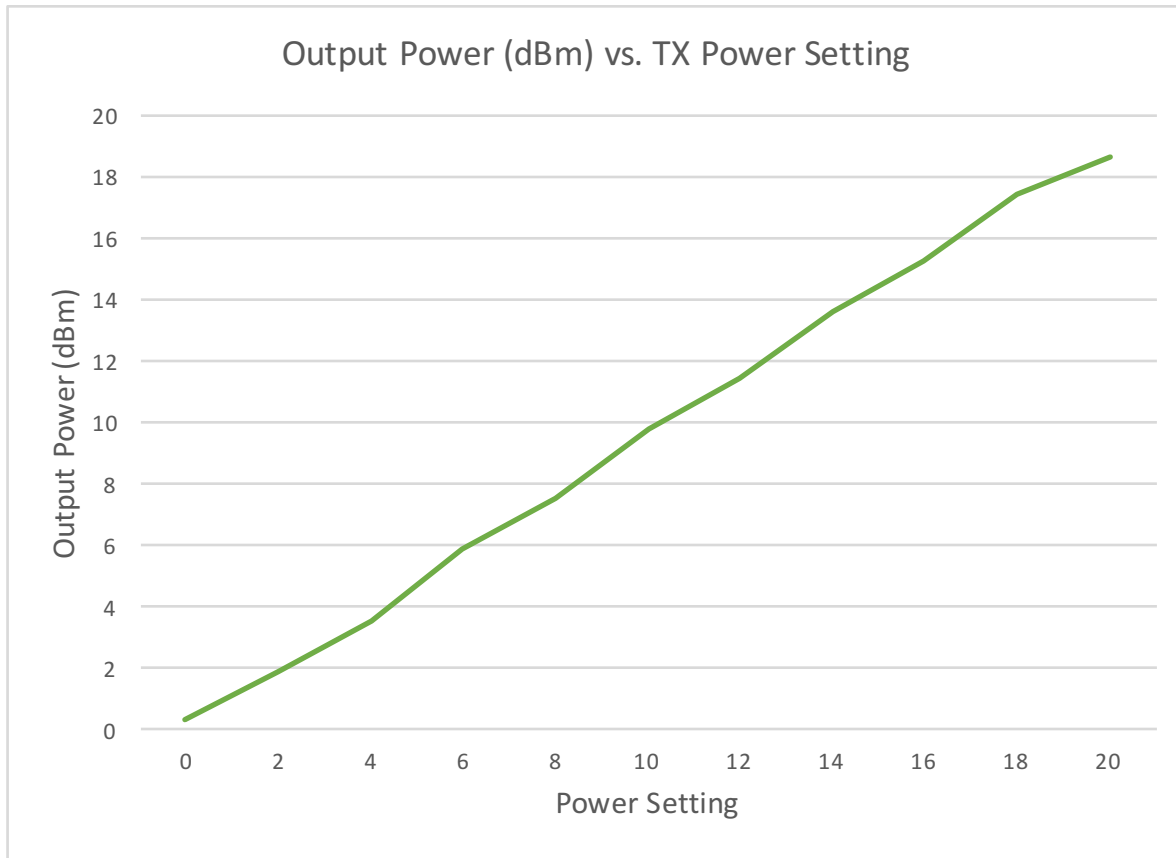

Note: The graph above is for the PA10 variant. For PA11 and PA12 modules, the maximum output power is limited by the chosen SKU (16.5dBm or 7dBm respectively)

6 | Functional Specifications

6.1 | Serial Ports

Refer to the EFR32MG1 data sheet for functionality and associated GPIO pinouts.

Note: The module pinout table in section 3 of this document provides a cross reference between the MMB module pins and the EFR32 GPIO.

Note 2: The RapidConnect firmware supports UART communication with a baud rate of 115.2kbps. However, MMB can modify this configuration as necessary through a Non-Recurring Engineering engagement.

7 | Mechanical Specifications

7.1 | Module Physical Dimensions and Host PCB Antenna Keep-out

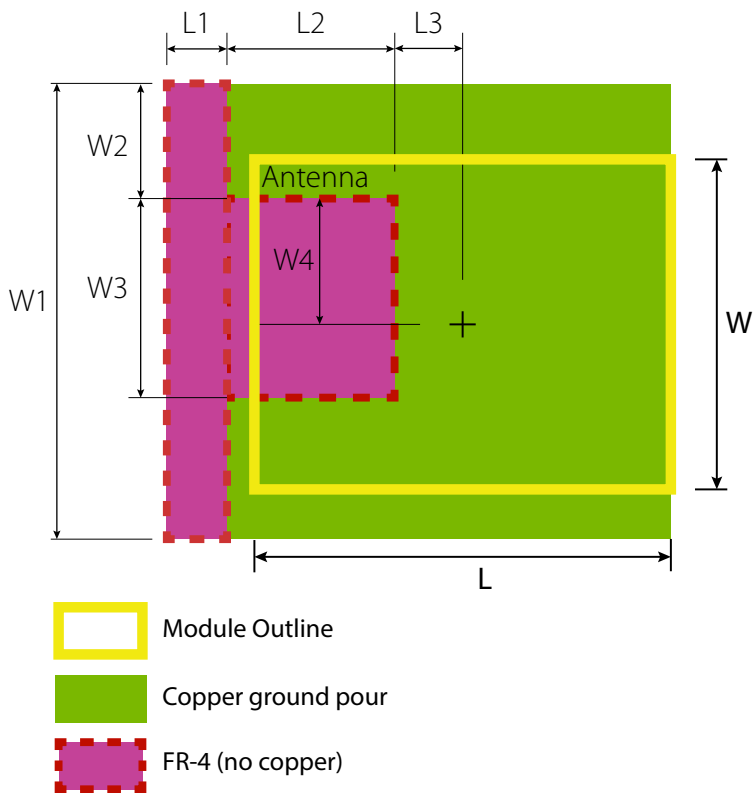

Symbol	Description	Distance
L	Length of the module	15.88 mm
W	Width of the module	12.60 mm
H	Height of the module	2.88 mm
L1	Second keep-out length	2.27 mm
L2	First keep-out length	6.43mm
L3	Length from module centre to edge of first keep-out	2.65 mm
W1	Second keep-out width	17.41mm
W2	Distance from edge of first keep-out to edge of second keep-out	4.41mm
W3	First keep-out width	7.62mm
W4	Width from module centre to edge of first keep-out	5.4 mm

Note: The above table and recommendation apply to BSB03PA1x-CHP products only. Copper keep-out regions apply to all PCB layers. BSB03PA1x-RFC have identical dimensions but do not require an antenna keep-out.

The BSB03PA1x family of devices use a System on Module (SOM) package process technology.

7.2 | Recommended Land Pattern (Surface Mount)

The diagram below shows the recommended dimensions and arrangement of the pads for the module. The PCB upon which the module will be mounted should not include any non-ground traces or vias on the top layer directly under the module. All copper features other than the module mounting pads, including ground vias, should be tented or covered with soldermask to avoid coming in contact with the module's traces and producing unexpected behavior. If it is absolutely necessary to include traces and/or vias under the module due to space constraints, then a customer can elect to do so at their own risk. MMB can provide a Hardware Designer Package to show the module's footprint and drill locations, which must not line up with the daughtercard's drill locations.

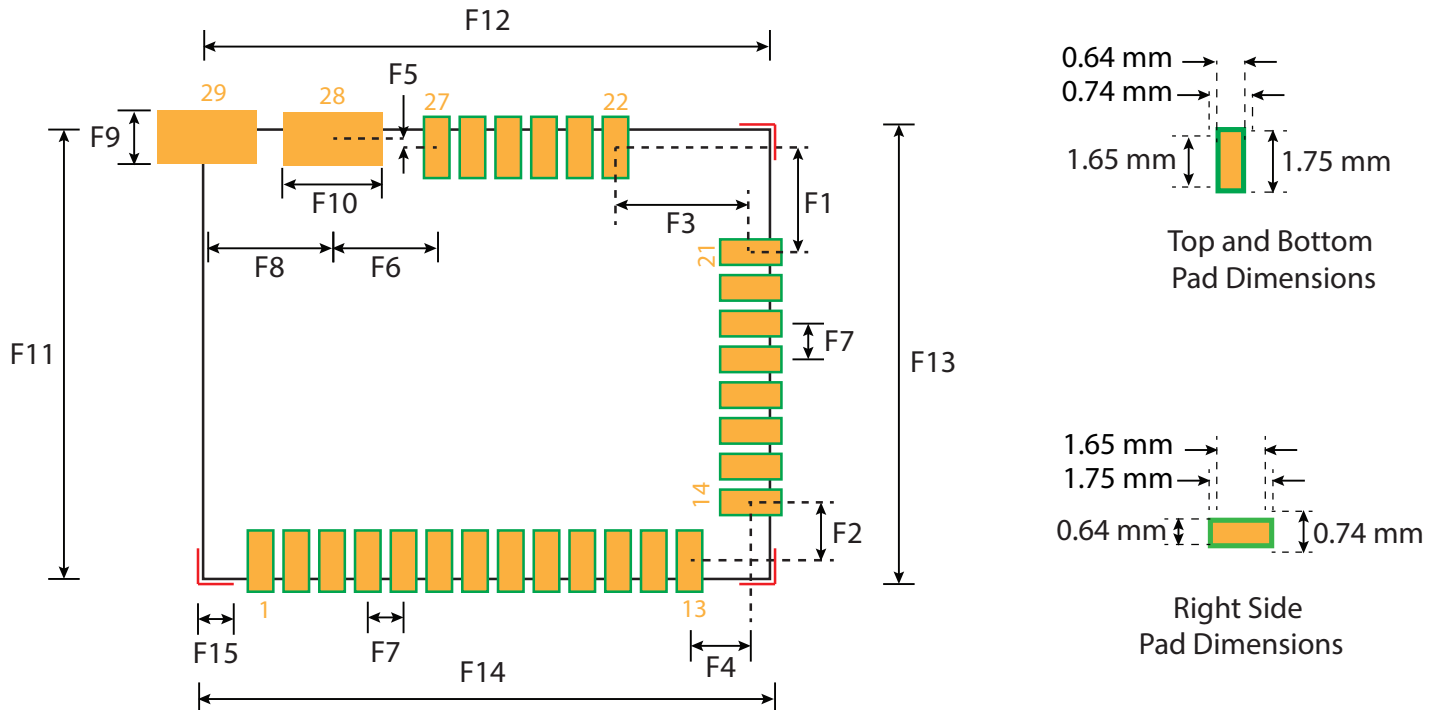

Note: Green box is the size of the top metal layer. Orange is the opening in the soldermask layer.

Symbol	Description	Distance
F1	Distance pad centre to pad centre (vertical: pad 21 to 22)	2.93 mm
F2	Distance pad centre to pad centre (vertical: pad 13 to 14)	1.67 mm
F3	Distance pad centre to pad centre (horizontal: pad 21 to 22)	3.77 mm
F4	Distance pad centre to pad centre (horizontal: pad 13 to 14)	1.69 mm
F5	Distance pad centre to RFGND centre (vertical: pad 27 to 28)	0.26 mm
F6	Distance pad centre to RFGND centre (horizontal: pad 27 to 28)	2.90mm
F7	Pitch (pad to pad)	1.02 mm
F8	Pitch (RFGND pad to RFGND pad)	3.52mm
F9	RFGND pad metal and soldermask width	1.47mm
F10	RFGND pad metal and soldermask length	2.78mm
F11	Module width	12.60 mm
F12	Module length	15.88 mm
F13	Width between silkscreen corners	12.90 mm
F14	Length between silkscreen corners	16.18 mm
F15	Size of silkscreen corner line	1 mm

7.3 | RF Connector Dimensions

The diagram below shows the dimensions for the RF connector. This connector appears on the -RFC variants only.

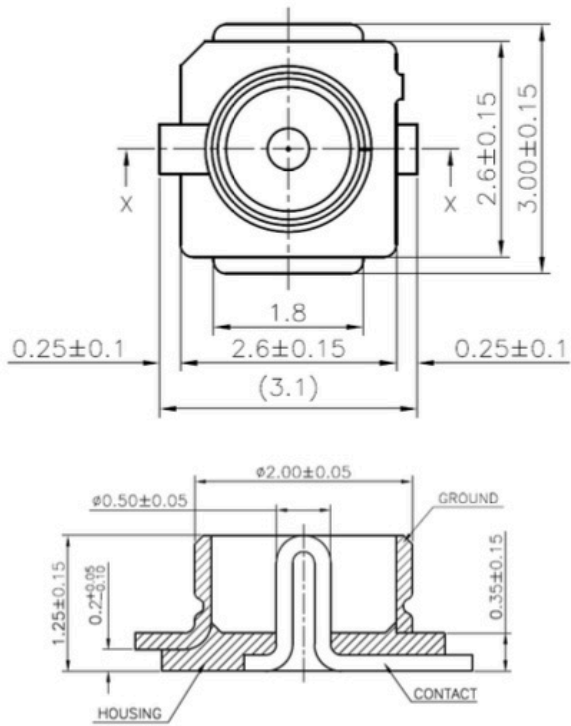

7.4 | Label Drawings

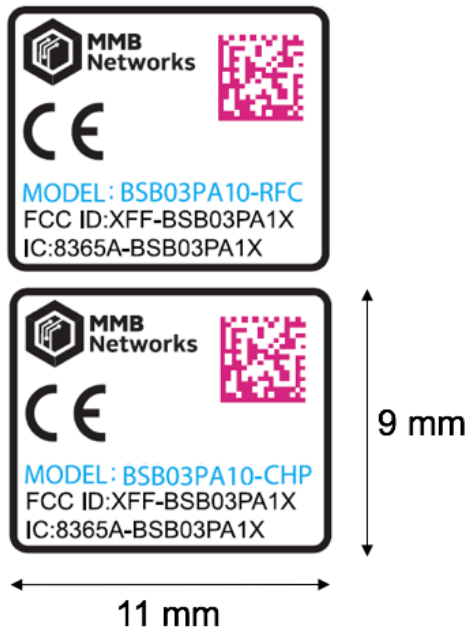

Note: The above is a sample only. The model number will vary depending on the SKU ordered.

8 | Soldering Temperature Time Profile for reflow soldering (Lead-free solder)

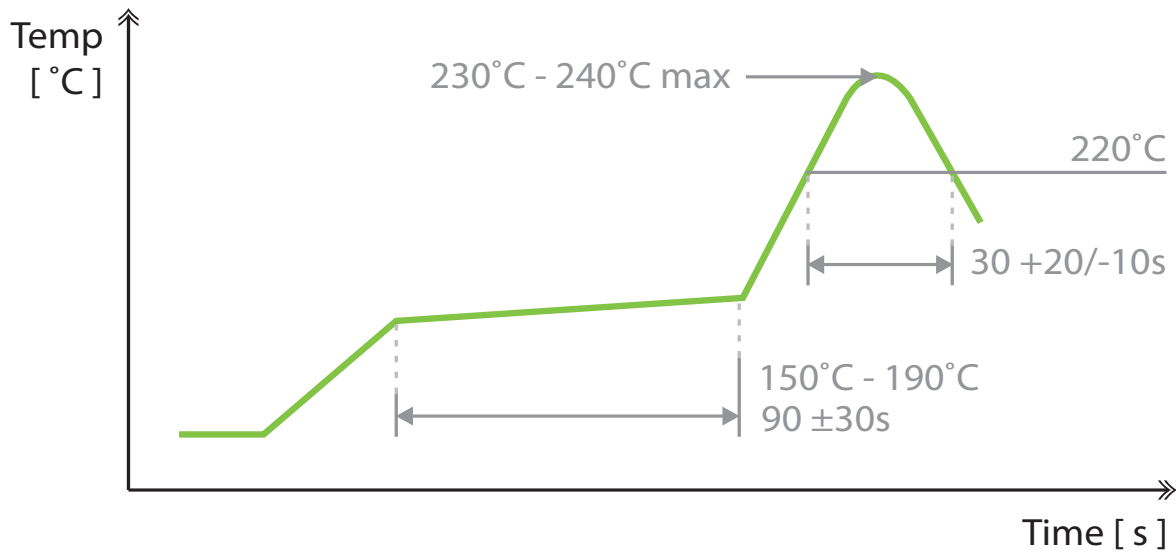

Maximum reflow cycles: 2

Opposite-side reflow is prohibited due to the module weight. You must not place the module on the bottom / underside of your PCB and re-flow.

9 | Regulatory Approvals

9.1 | Federal Communications Commission (FCC - US)

Note: this section applies to BSB03PA1x-CHP and BSB03PA1x-RFC devices only.

9.1.1 | Approved Antennae

For the BSB03PA1x-CHP modules using the onboard chip antenna, the approved power level settings are 20 dBm for channels 11-25 and 7 dBm for channel 26. The onboard chip antenna is Inpaq ACA-2012-A1-CC-S.

For the BSB03PA1x-RFC modules using the approved external antenna, the approved power level settings are 20 dBm for channels 11-25 and 9 dBm for channel 26. The BSB03PA1x-RFC devices have been approved with the following external FCC approved antennas: Mag Layers EDA-1713-2G4C1-A2, and Bondale G-RA0K13200284-SZ478.

9.1.2 | FCC Notice

The BSB03PA1x-CHP and BSB03PA1x-RFC devices comply with Part 15 of the FCC rules. Operation is subject to the following two conditions:

- (1) This device may not cause harmful interference, and
- (2) This device must accept any interference received, including interference that may cause undesired operation.

To comply with FCC RF Exposure requirements, users of this device must ensure that the module be installed and/or configured to operate with a separation distance of 20cm or more from all persons.

Usage of Channel 26 at full power will result in non-compliance to FCC standards. MMB recommends avoiding use of channel 26 and if necessary only use with a reduced power setting. For further details please contact MMB.

This equipment has been tested and found to comply with the limits for a Class B digital device, pursuant to Part 15 of the FCC Rules. These limits are designed to provide reasonable protection against harmful interference in a residential installation. This equipment generates, uses and can radiate radio frequency energy and, if not installed and used in accordance with the instructions, may cause harmful interference to radio communications. However, there is no guarantee that interference will not occur in a particular installation. If this equipment does cause harmful interference to radio or television reception, which can be determined by turning the equipment off and on, the user is encouraged to try to correct the interference by one of the following measures:

- Reorient or relocate the receiving antenna.
- Increase the separation between the equipment and receiver.
- Connect the equipment into an outlet on a circuit different from that to which the receiver is connected.
- Consult the dealer or an experienced radio/TV technician for help.

9.1.3 | Modular Approval

The BSB03PA1x-CHP and BSB03PA1x-RFC devices meet the requirements for modular transmitter approval as detailed in the FCC public notice DA 00-1407.

It should be noted that:

“While the applicant for a device into which an authorized module is installed is not required to obtain a new authorization for the module, this does not preclude the possibility that some other form of authorization or testing may be required for the device (e.g., a WLAN into which an authorized module is installed must still be authorized as a PC peripheral, subject to the appropriate equipment authorization).”

-- FCC Public Notice DA 00-1407

Caution:

Changes or modifications not expressly approved by the party responsible for compliance could void the user’s authority to operate the equipment.

NOTE:

This module is intended for an OEM integrator. The OEM integrator is responsible for the compliance to all the rules that apply to the product into which this certified RF module is integrated. Additional testing and certification may be necessary when multiple modules are used.

A 20cm minimum distance has to be able to be maintained between the antenna and the users for the host this module is integrated into. Under such configuration, the FCC radiation exposure limits set forth for a population/uncontrolled environment can be satisfied.

Further RF exposure shall be re-evaluated to the scenario of portable, and collocated use.

USER MANUAL OF THE END PRODUCT:

In the user manual of the end product, the end user has to be informed to keep at least 20cm separation with the antenna while this end product is installed and operated. The end user has to be informed that the FCC radio-frequency exposure guidelines for an uncontrolled environment can be satisfied.

The end user has to also be informed that any changes or modifications not expressly approved by the manufacturer could void the user’s authority to operate this equipment.

9.1.4 | Labeling Requirements

The user of this device is responsible for meeting the FCC labeling requirements. A clearly visible label on the exterior enclosure of an incorporating device must list the MMB Research Inc. FCC ID "XFF-BSB03PA1X" and the FCC Notice above (section 9.1.1).

The exterior label should use the wording "Contains" or "Contains Transmitter Module". For example:

Contains FCC ID: XFF-BSB03PA1X

or

Contains Transmitter Module FCC ID: XFF-BSB03PA1X

Any similar wording that expresses the same meaning may be used.

If the labelling area is smaller than the palm of the hand, then additional FCC part 15.19 statement is required to be available in the users manual: This device complies with Part 15 of FCC rules. Operation is subject to the following two conditions: (1) this device may not cause harmful interference and (2) this device must accept any interference received, including interference that may cause undesired operation.

LABEL OF THE END PRODUCT:

The final end product must be labeled in a visible area with the following "Contains TX FCC ID: XFF-BSB03PA1X".

If the labelling area is larger than the palm of the hand, then the following FCC part 15.19 statement has to also be available on the label: This device complies with Part 15 of FCC rules. Operation is subject to the following two conditions: (1) this device may not cause harmful interference and (2) this device must accept any interference received, including interference that may cause undesired operation.

9.2 | Industry Canada (IC)

Note: this section applies to BSB03PA1x-CHP and BSB03PA1x-RFC devices only.

9.2.1 | Approved Antennae

For the BSB03PA1x-CHP modules using the onboard chip antenna, the approved power level settings are 20 dBm for channels 11-25 and 7 dBm for channel 26.

For the BSB03PA1x-RFC modules using the approved external antenna, the approved power level settings are 20 dBm for channels 11-25 and 9 dBm for channel 26.

9.2.2 | IC Notice

This device complies with Industry Canada licence-exempt RSS standard(s).

Operation is subject to the following two conditions:

- (1) this device may not cause interference, and
- (2) this device must accept any interference, including interference that may cause undesired operation of the device.

Le présent appareil est conforme aux CNR d'Industrie Canada applicables aux appareils radio exempts de licence.

L'exploitation est autorisée aux deux conditions suivantes :

- (1) l'appareil ne doit pas produire de brouillage, et
- (2) l'utilisateur de l'appareil doit accepter tout brouillage radioélectrique subi, même si le brouillage est susceptible d'en compromettre le fonctionnement.

9.2.3 | Labeling Requirements

The host device shall be properly labelled to identify the modules within the host device. The Industry Canada certification label of a module shall be clearly visible at all times when installed in the host device, otherwise the host device must be labelled to display the Industry Canada certification number of the module, preceded by the words “Contains transmitter module”, or the word “Contains”, or similar wording expressing the same meaning, as follows:

Contains transmitter module IC: 8365A-BSB03PA1X

Contient le émetteur radio IC: 8365A-BSB03PA1X

9.3 | EU

Note: this section applies to BSB03PA1x-CHP and BSB03PA1x-RFC devices only.

BSB03PA1x-CHP and BSB03PA1x-RFC devices are compliant with the following EU standards: ETSI EN 300 328 (v2.1.1), ETSI EN 301 489 1 (v2.1.1) and ETSI EN 301 489 17 (v2.2.1), provided that the transmit power level is set to 11 dBm for CHP modules or 8 dBm for RFC modules.

These devices are also compliant with 2014/53/EU.

9.4 | RoHS Compliance

The BSB03PA1X devices do not contain any substances in excess of the maximum concentration allowed by Directive 2002/95/EC. The module is RoHS compliant.

10 | Revision History

Revision	Date	Comments
1.1	2018/06/25	Updates to SKU numbers, and Channel 26 power numbers.
1.0	2018/03/19	Moved to Final datasheet. Updates to specifications, land pattern, keep-out and ordering sections.
0.7	2018/02/13	Added Debug and Programming Section, Updated FCC/IC section
0.6	2017/11/21	Updated dimensions, package type, and ordering information
0.5	2017/10/04	Regulatory Information added
0.4	2017/09/15	New SKU names, minor updates
0.3	2017/08/24	Added PA11 and PA12 variants
0.2	2017/07/10	Minor updates
0.1	2017/05/29	Initial draft

11 | Ordering Information

Hardware SKU	Regulatory Approvals	Max Output Power (dBm)	RF Output Option	Status
BSB03PA10-CHP-N	FCC/IC	19.5	Chip Antenna	Mass Production
BSB03PA10-PIN-X	N/A ¹	19.5	Module Pad 1	Mass Production
BSB03PA10-RFC-N	FCC/IC	19.5	RF Connector	Mass Production
BSB03PA11-CHP-D	CE, FCC/IC	10.5	Chip Antenna	Mass Production
BSB03PA11-CHP-N	FCC/IC	16.5	Chip Antenna	Mass Production
BSB03PA11-PIN-X	N/A ¹	16.5	Module Pad 1	Mass Production
BSB03PA11-RFC-N	FCC/IC	16.5	RF Connector	Mass Production
BSB03PA12-CHP-D	CE, FCC/IC	7	Chip Antenna	Mass Production
BSB03PA12-PIN-X	N/A ¹	7	Module Pad 1	Mass Production
BSB03PA12-RFC-D	FCC/IC, CE	7	RF Connector	Mass Production

Notes:

1. The PIN variant of the module has no regulatory approvals. Host manufacturers who decide to use this variant are responsible for full certification of the product.

The above table provides the HW SKU which forms the first part of the complete part number. The complete part number takes the format: BSB03PA1x-yyy-r-zzz. Where r is the regulatory region (E=Europe, N=North America, D=Dual), and zzz represents a three digit programming code.

Contact your local MMB sales representative to determine the correct programming code for your application.

Copyright © 2018 MMB Research Inc. All rights reserved.

The information in this document is subject to change without notice. This document is believed to be accurate and reliable, but the statements contained herein are presented without expressed or implied warranty.

MMB Networks is a division of MMB Research Inc. RapidSE, RapidHA, and RapidConnect are trademarks of MMB Research Inc. All other trademarks are the property of their respective holders.



500 -243 College Street
Toronto, Ontario, Canada
M5T 1R5

416.636.3145
info@mmbnetworks.com
www.mmbnetworks.com

June 2018